

STANDARD DUTY BALL - Metallic

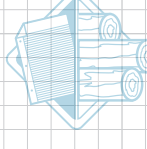

VARIABLE HEADS

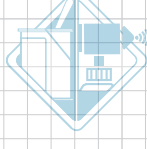
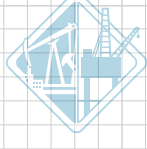
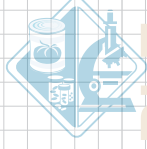
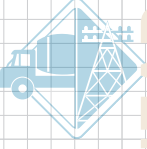
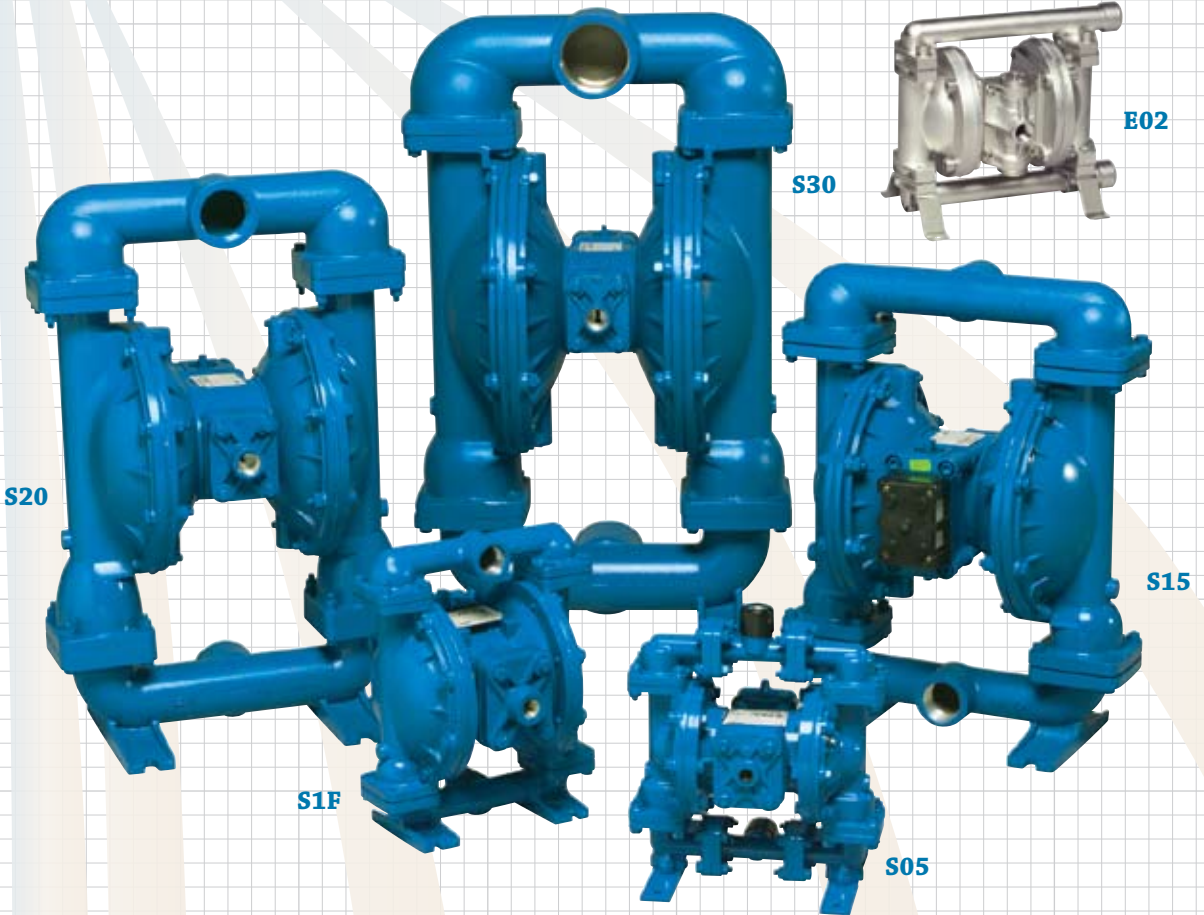

Standard Duty Metallic Pumps are ideally suited for intermittent/on-demand, portable, moderately abrasive fluids, and suspended solids. Standard duty metallic pumps are constructed in Aluminum, Cast Iron, Stainless Steel and Alloy C with elastomer TPE (thermal plastic elastomers) and PTFE options in diaphragms and check valves.

Metallic standard duty pumps handling suspended solids in an industrial waste treatment operation.



Dimensional Detail

Metallic standard duty pumps installed for exterior sump pumping requirements.

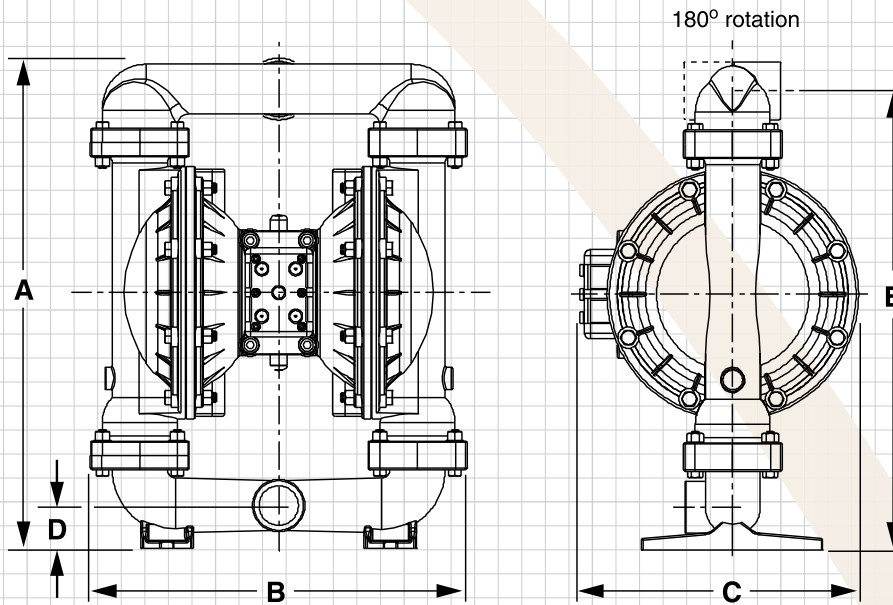

PUMP MODELS	A	B	C	D		Connection Style	Pipe Size	Displacement Per Stroke	Max Flow Per Minute	Max Solids Handling	Max Discharge Pressure
	Height	Width	Depth	Bottom of Base to Center Line of Suction Discharge							
	inches (mm)	inches (mm)	inches (mm)	inches (mm)	inches (mm)						
E02	5 13/16 (148)	7 7/16 (189)	4 3/8 (111)	5/8 (16)	5 13/32 (138)	1/4" NPT	.25 (6)	.003 (.01)	4.4 (16.6)	.079 (2)	125 (8.6)
S05 AL	11 1/2 (292)	10 1/4 (260)	7 1/16 (179)	1 5/16 (33)	11 1/2 (292)	1" MNPT	.5 (13)	.026 (.098)	15 (57)	.125 (3)	125 (8.6)
S05 SS	10 3/8 (264)	10 1/4 (260)	7 1/16 (179)	1 5/16 (33)	9 23/32 (247)	1" MNPT	.5 (13)	.026 (.098)	15 (57)	.125 (3)	125 (8.6)
S1F AL / CI	12 23/32 (323)	10 1/4 (260)	10 3/8 (264)	1 3/32 (28)	11 27/32 (301)	1" NPT	1 (25)	.11 (.42)	45 (170)	.25 (6)	125 (8.6)
S1F SS	12 27/32 (326)	10 1/4 (260)	10 3/8 (264)	1 7/32 (31)	11 31/32 (304)	1" NPT	1 (25)	.11 (.42)	45 (170)	.25 (6)	125 (8.6)
S15 AL / CI	21 37/64 (548)	16 21/32 (423)	12 23/64 (314)	1 29/32 (49)	20 5/16 (516)	1 1/2" NPT	1.5 (40)	.41 (1.55)	106 (401)	.25 (6)	125 (8.6)
S15 SS	21 21/32 (550)	16 21/32 (423)	12 23/64 (314)	1 31/32 (50)	20 3/8 (518)	1 1/2" NPT	1.5 (40)	.41 (1.55)	106 (401)	.25 (6)	125 (8.6)
S20 AL / CI	26 5/16 (669)	16 7/8 (428)	12 19/32 (320)	1 7/8 (48)	24 5/8 (625)	2" NPT	2 (50)	.42 (1.59)	150 (567)	.25 (6)	125 (8.6)
S20 SS	26 5/16 (669)	16 7/8 (428)	12 19/32 (320)	2 (51)	24 3/4 (629)	2" NPT	2 (50)	.42 (1.59)	150 (567)	.25 (6)	125 (8.6)
S30 AL/CI	32 1/16 (814)	19 21/32 (499)	15 3/4 (400)	2 11/32 (60)	29 31/32 (761)	3" NPT	3 (80)	.94 (3.56)	238 (901)	.38 (9.5)	125 (8.6)
S30 SS	32 9/32 (820)	19 21/32 (499)	15 3/4 (400)	2 9/32 (65)	30 3/16 (767)	3" NPT	3 (80)	.94 (3.56)	238 (901)	.38 (9.5)	125 (8.6)

All Dimensions +/- 1/8 (3)

With more ways than one!